

RoHS Compliant Product

A suffix of "-C" specifies halogen-free and RoHS Compliant

FEATURES

- Heatsink Structure
- Low Profile, Typical Thickness 0.8mm
- Moisture Sensitivity: Level 1, Per J-STD-020
- High Temperature Soldering Guaranteed: 260°C/10 Seconds

MARKING



↑
Cathode

PACKAGE INFORMATION

Package	MPQ	Leader Size
SOD-123DT	3K	7 inch

ORDER INFORMATION

Part Number	Type
SM120DT~SM140DT	Lead (Pb)-free
SM120DT-C~SM140DT-C	Lead (Pb)-free and Halogen-free

SOD-123DT

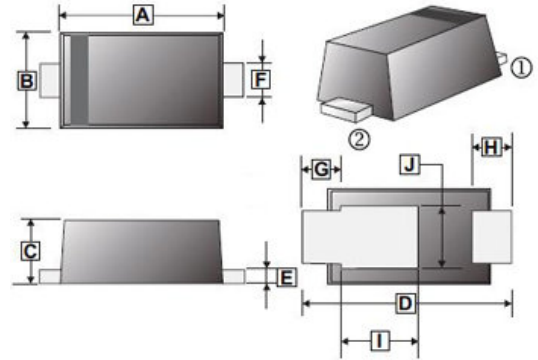

REF.	Millimeter		REF.	Millimeter	
	Min.	Max.		Min.	Max.
A	2.9	3.1	F	0.85	1.05
B	1.9	2.1	G	0.6 REF.	
C	0.75	0.9	H	0.4	0.85
D	3.5	3.9	I	1.66 REF.	
E	0.1	0.25	J	1.3	1.7

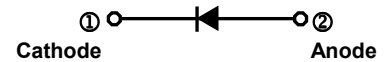

MAXIMUM RATINGS AND ELECTRICAL CHARACTERISTICS (T_A=25°C unless otherwise specified)

Parameter	Symbol	Part Number			Unit
		SM120DT	SM130DT	SM140DT	
Maximum Repetitive Peak Reverse Voltage	V _{RRM}	20	30	40	V
Maximum RMS Voltage	V _{RMS}	14	21	28	V
Maximum DC Blocking Voltage	V _{DC}	20	30	40	V
Minimum Breakdown Voltage @I _R =1mA	V _{BR}	20	30	40	V
Maximum Average Forward Rectified Current	I _F	1			A
Peak Forward Surge Current@ 8.3 ms Single Half Sine-Wave Superimposed on Rate Load	I _{FSM}	30			A
Rating for Fusing (t<8.3ms)	I ² t	4			A ² S
Maximum Instantaneous Forward Voltage	V _F	I _F =1A, T _A =25°C	0.5		V
		I _F =1A, T _A =75°C	0.5		
Maximum DC Reverse Current at Rated DC Blocking Voltage	I _R	T _A =25°C	50		uA
		T _A =75°C	1		mA
Typical Junction Capacitance	C _J	51.2			pF
Typical Thermal Resistance from Junction to Ambient ¹	R _{θJA}	65			°C/W
Typical Thermal Resistance from Junction to Case ²	R _{θJC}	35			
Typical Thermal Resistance from Junction to Lead ¹	R _{θJL}	9			
Operating Junction and Storage Temperature	T _J , T _{STG}	-55~150			°C

Notes:

1. The thermal resistance from junction to ambient or lead, mounted on P.C.B with 5×5mm copper pads, 2 OZ, FR4 PCB.
2. The thermal resistance from junction to case, mounted on P.C.B with recommended copper pads, 2 OZ, FR4 PCB.

CHARACTERISTIC CURVES

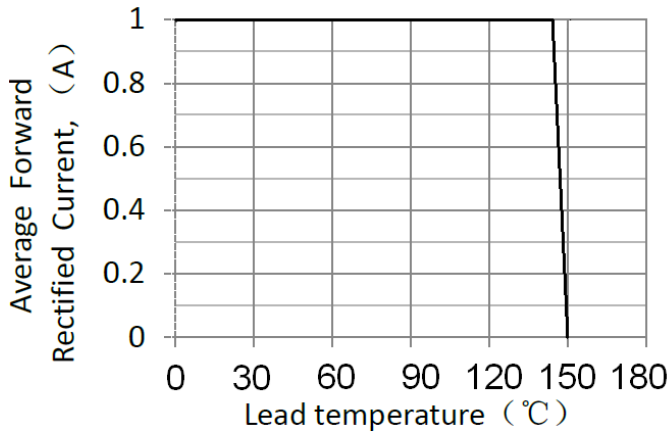

Figure 1. Forward Current Derating Curve

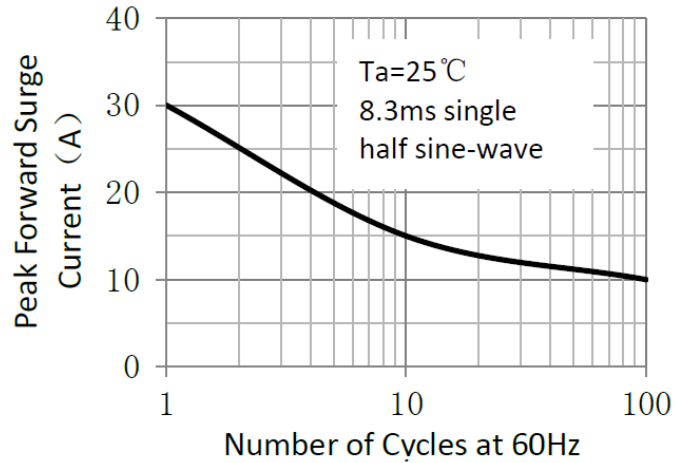

Figure 2. Maximum Non-Repetitive Peak Forward Surge Current

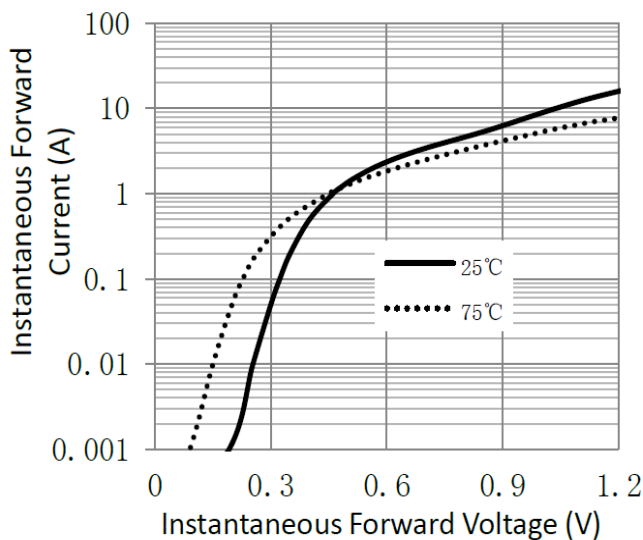

Figure 3. Typical Instantaneous Forward Characteristics

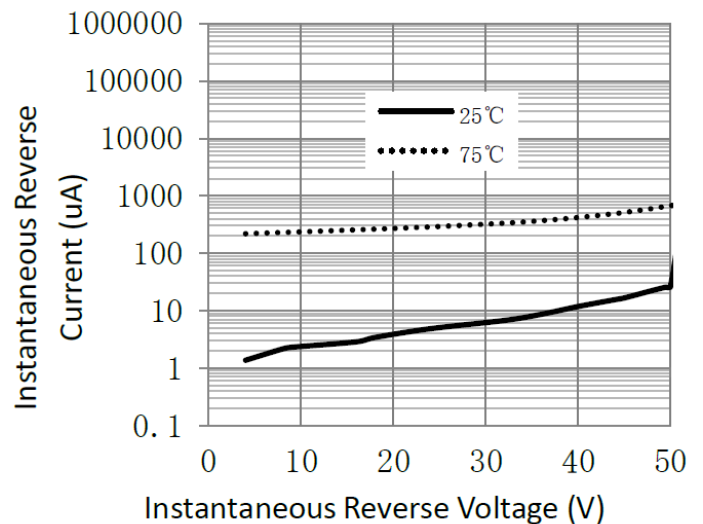

Figure 4. Typical Reverse Characteristics

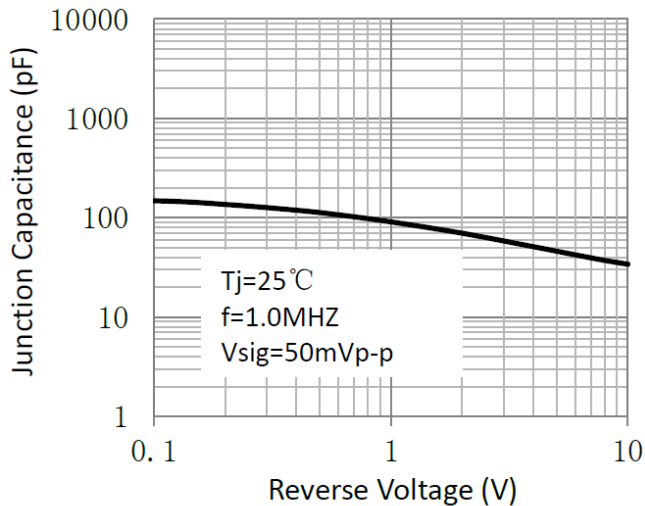

Figure 5. Typical Junction Capacitance